

Charnroe®



BOXWOOD II ECO DESIGN STOVE

PART NO: 6910142

USER GUIDE

**UK
RA**

ORIGINAL INSTRUCTIONS

26 January 24 GC Rev 1

INTRODUCTION

Thank you for purchasing this CLARKE stove which is approved for use in smoke-controlled zones. It is designed and produced according to the standard EN13240+Amendment A2:2004.

The stove is supplied with various removable components including the lining panels, log retainer, ash pan and handle which require checking for correct fitting.

Before attempting to operate the stove, it is essential that you read this manual thoroughly and carefully follow all instructions given. In doing so you will ensure the safety of yourself and that of others around you, and you can also look forward to the product giving you long and satisfactory service.

TECHNICAL SPECIFICATIONS

	Wood	Smoke-less	Fir Wood	
Compatible Fuel	Yes	No	Yes	
Weight (kg)	91			
Dimensions (mm) W x H x D *	579 x 713 x 428			
Door Aperture (mm) W x H	410 x 340			
Compatible Flue Diameter (")	5			
Maximum Fuel Size (mm)	280 x 100			
Energy Efficiency (%)	76.8	N/A	NPD	
Nominal Heat Output (kW)	5.5	N/A	NPD	
Space Heat Output (kW)	as above			
Carbon Monoxide (vol%)	Emissions at 13% O ₂	0.10	N/A	NPD
Nitrogen Oxide (mg/Nm³)		93	N/A	NPD
Organic Gas Compounds (mg/Nm³)		65	N/A	NPD
Particulate Matter (mg/Nm³)		16	N/A	NPD
Hearth Temperature (°C)	48.3	N/A	126.7	
Flue Mass Flow (g/s)	5.3			
Recommended Chimney Draft (Pa)	12			

N/A = fuel type not supported, NPD = no performance determined.

* = excludes handles, controls and levers

INSTALLATION OF THIS PRODUCT



WARNING: AN ACCREDITED HEATING ENGINEER MUST CARRY OUT THE INSTALLATION OF THIS STOVE. ALTERNATIVELY, SHOULD A NON-ACCREDITED ENGINEER UNDERTAKE THE INSTALLATION, YOUR LOCAL BUILDING CONTROL OFFICER WILL BE REQUIRED TO APPROVE THE COMPLETED INSTALLATION UNDER BUILDING REGULATION "J". IT IS AN OFFENCE UNDER UK LAW, NOT TO COMPLY WITH THIS MANDATORY REQUIREMENT. IF THE STOVE IS NOT FITTED CORRECTLY BY AN APPROVED PERSON, IT COULD RESULT IN A HOUSE FIRE OR CARBON MONOXIDE POISONING.

READ ALL INSTRUCTIONS CAREFULLY BEFORE INSTALLATION



CAUTION: The instructions cover the basic principles to ensure satisfactory installation of the stove, although detail may need slight modification to suit particular site conditions. In all cases the installation must comply with current Building Regulation 'J', Local Authority By-laws, European and National standards and any other specifications or regulations as they affect the installation of the stove.

CAUTION: The information contained in this manual includes extracts from the Building Regulations 2000 "Approved Document J" (Combustion Appliances and Fuel Storage Systems), updated 2013. This guidance information in no way replaces your responsibility as an installer or end user to comply with the appropriate standards.

GUARANTEE

This CLARKE product is guaranteed against faulty manufacture for a period of 12 months from the date of purchase. Please keep your receipt as proof of purchase.

This guarantee is invalid if the product is found to have been abused or tampered with in any way, or not used for the purpose for which it was intended. Faulty goods should be returned to their place of purchase, no product can be returned to us without prior permission.

This guarantee does not effect your statutory rights.

CLEAN AIR ACT 1993 & SMOKE CONTROL AREAS

Under the Clean Air Act local authorities may declare the whole or part of the district of the authority to be a smoke control area. It is an offence to emit smoke from a chimney of a building, from a furnace or from any fixed boiler if located in a designated smoke control area. It is also an offence to acquire an "unauthorised fuel" for use within a smoke control area unless it is used in an "exempt" appliance ("exempted" from the controls which generally apply in the smoke control area).

In England appliances are exempted by publication on a list by the Secretary of State in accordance with changes made to sections 20 and 21 of the Clean Air Act 1993 by Section 15 of the Deregulation Act 2015. Similarly in Scotland appliances are exempted by publication on a list by Scottish Ministers under section 50 of the Regulatory Reform (Scotland) Act 2014. In Northern Ireland appliances are exempted by publication on a list by the Department of Agriculture, Environment and Rural Affairs under Section 16 of the Environmental Better regulation Act (Northern Ireland) 2016.

In Wales appliances are exempted by regulations made by Welsh ministers.

Further information on the requirements of the Clean Air Act can be found here:

<https://www.gov.uk/smoke-control-area-rules>

Your local authority is responsible for implementing the Clean Air Act 1993 including designation and supervision of smoke control areas and you can contact them for details of Clean Air Act requirements.

This stove has been recommended as suitable for use in smoke control areas when burning wood logs. The Regal IV must be fitted with a permanent stop to prevent closure of the secondary air control beyond 50% open.

Please note the following advice on minimising smoke emissions:

REFUELLING ON TO A LOW FIRE BED

If there is insufficient burning material in the fire-bed to light a new fuel charge, excessive smoke emission can occur. Refuelling must be carried out onto a sufficient quantity of glowing embers and ash that the new fuel charge will ignite in a reasonable period. If there are too few embers in the fire bed, add suitable kindling to prevent excessive smoke.

FUEL OVERLOADING

The maximum amount of fuel used should not constitute overloading likely to cause excess smoke.

OPERATION WITH DOOR LEFT OPEN

Operation with the door open can cause excess smoke. DO NOT operate the stove with the door open except when re-fuelling.

DAMPERS LEFT OPEN

Operation with the air controls or appliance dampers open can cause excess smoke. The appliance must not be operated with air controls, appliance dampers or door left open except as directed in the instructions.

SAFETY WARNINGS FOR YOUR GUIDANCE



CAUTION: FIRES CAN BE DANGEROUS - ALWAYS use a fireguard in the presence of children, the elderly or the infirm. The fireguard should be manufactured in accordance with B.S. 6539 - Fireguards for use with solid fuel appliances.

CAUTION: DO NOT OVERFIRE - It is possible to fire the stove beyond its design capacity. This could damage the stove, so watch for signs of overfiring - if any part of the stove starts to glow red, the stove is in an overfire situation and the controls should be adjusted accordingly. Never leave the stove unattended for long periods without first adjusting the controls to a safe setting. Careful air supply control should be exercised at all times.

CAUTION: THIS STOVE MUST BE CONNECTED TO A SUITABLE FLUE OUTLET. Due to high temperature this stove should be located well away from furniture and curtains. Children and adults should be alerted to the hazards of hot surfaces. Young children should be carefully supervised when they are in the same room as the stove. Do not place clothing or other flammable material on or near the stove. Keep the stove area clear of combustible materials, flammable liquids or vapours.

CAUTION: CARBON MONOXIDE POISONING CAN BE FATAL. Carbon Monoxide detectors to BS EN 50291 are available for use in domestic premises and details are available in the official HETAS guide that can be viewed on their website at www.hetas.co.uk. Due consideration should be given to the dangers of carbon monoxide poisoning following incomplete combustion of solid fuels in an enclosed space. SEE PAGE 18 OF THIS BOOKLET.

GENERAL SAFETY RULES



WARNING: THIS STOVE WILL BE HOT WHEN IN OPERATION AND DUE CARE SHOULD BE TAKEN. HEAT RESISTANT GLOVES SHOULD BE USED TO OPERATE THE PRIMARY/SECONDARY CONTROLS OR REACHING INSIDE THE STOVE TO POSITION FUEL OR REMOVE ASH.

1. **ALWAYS** read and understand the manual before installing and commissioning the stove.
2. **ALWAYS** check for damage before using the stove. Check for breakage of parts and any other condition that may affect the stoves performance. Any damage should be properly repaired or the part replaced. If in doubt, **DO NOT** use the stove. Consult your local dealer. Always ensure the stove is installed in accordance with local regulations.
3. **ALWAYS** ensure that the stove is correctly installed and positioned as described under POSITIONING AND INSTALLATION, and that the immediate area is kept clear.
4. **ALWAYS** keep children and visitors at a safe distance from the stove.
5. **NEVER** direct any kind of liquid on to the stove, particularly when it is hot.
6. **NEVER** use petrol or other flammable liquids for fire starting.
7. **NEVER** use the stove to incinerate materials other than recommended fuels.
8. **NEVER** carry out any modifications to this product. If experiencing difficulty of any kind consult your local dealer.
9. The installation of the stove and chimney **MUST** comply with all National, European and local building regulations. It is the responsibility of the owner and the installer to ensure that the installation complies.
10. All rooms where a stove is situated must have a non-motorised air vent. Refer to details contained in the Building Regulations.

IMPORTANT: Building Regulation "J" is the Government approved document covering the installation of solid fuel stoves.

UNPACKING

UNPACKING



WARNING: DUE TO THE WEIGHT OF THE STOVE IT IS ADVISED THAT TWO PEOPLE PERFORM THE UNPACKING AND POSITIONING.

Unpack the stove and remove packing materials. Open the door and remove the loose items from inside the stove.

Before proceeding, please check contents against the following list and advise your dealer immediately if any parts are missing. Refer also to parts list & diagram on page 28.

A full range of flue pipes and fire cement is available from your CLARKE dealer.

- Stove
- Flue Collar c/w gasket
- Rear Linear (Baffle) panel
- Ashpan and handle
- Heat resistant mitt
- Hex key (supplied)

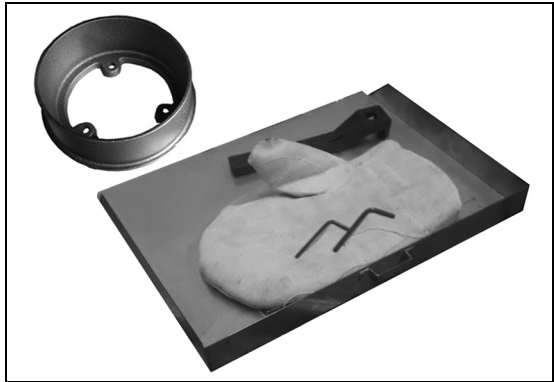

TOOLS REQUIRED

- CLARKE Fire Cement (Part No 691000)
- 13mm spanner

ASSEMBLY

1. Attach the flue adaptor using the screws supplied, ensuring the rope fireproof gasket is correctly seated.
2. Check that the top plate, firebricks, top baffle and log retainer have not been dislodged during transit and re-position if required.
3. Slide the ashpan into position.
 - An ashpan handle is supplied for when the stove is in use.
4. Position the stove in the desired location as shown in POSITIONING AND INSTALLATION. Take care not to damage the floor surface.
5. Level the stove on the floor provided, using the levelling bolts on each leg, taking care not to damage the floor surface.
6. If there are any gaps between the components, these should be filled with CLARKE fire cement to prevent smoke emissions.

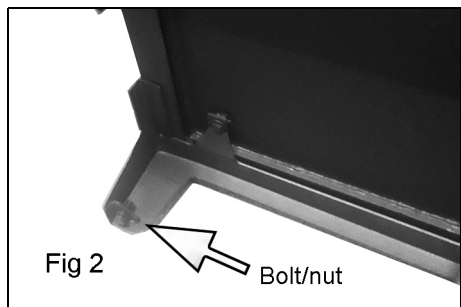
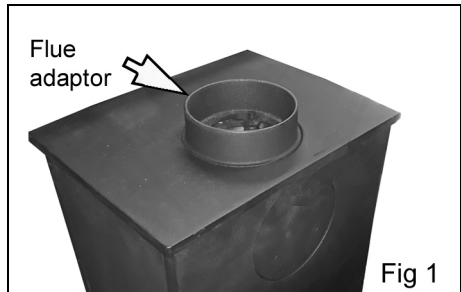

POSITIONING AND INSTALLATION

REGULATORY COMPLIANCE

In England and Wales, there are only two routes to legally install a domestic solid fuel or wood burning appliance. In other parts of the UK there are variations in legislation and processes.

You can either:

- Use a registered installer who can self certify that the work he does complies with the relevant Building Regulations; or
- The consumer applies to their local authority building control department for a building notice, and pays the appropriate fee.

It is generally worthwhile to use a HETAS registered installer who will supply a Certificate of Compliance as a record of the job and that it complies with Building Regulations. A copy of the certificate is forwarded to HETAS who notify the local authority on your behalf.

Failure to notify the work through the registration scheme (in this case HETAS) or directly to the local authority can lead to enforcement. It can also cause problems for future house sales if there is no official record of a compliant installation. All local regulations, including those referring to National and European Standards need to be complied with when installing this appliance.

For specific guidance when cast iron stoves are being installed in boats or in homes with thatched roofs, please refer to the SOLIFTEC website at:

www.soliftec.com/installation.htm

SUPPORTING FLOORS

The stove must only be installed on floors with an adequate load bearing capacity and if the existing construction is not suitable, additional measures such as a load distributing plate must be provided.

The hearth should be able to accommodate the weight of the stove and its chimney if the chimney is not independently supported. Stoves should stand wholly above hearths made of non-combustible board/sheet material or tiles at least 12mm thick, if the stove is not to stand in a recess and has been tested to an applicable standard to verify that it cannot cause the temperature of the upper surface of the hearth to exceed 100°C.

Constructional hearths should be made of solid, non-combustible material such as concrete or masonry, at least 125mm thick, including the thickness of any non-combustible floor and/or decorative surface.

Specific guidance for surfaces on which the stove may be allowed to stand is given in Approved Document J and must be followed.

When the stove is positioned near a wall constructed of flammable material, the distances shown on Fig 3 must be adhered to. Alternatively, a heat shield may be used, mounted according to the position of the fireplace. A firewall must be at least 100mm thick and typically made of brick, or concrete/stone.

MATERIAL CLEARANCES

The stove must have a minimum clearance of 300mm to a combustible ceiling above.

FIG 3

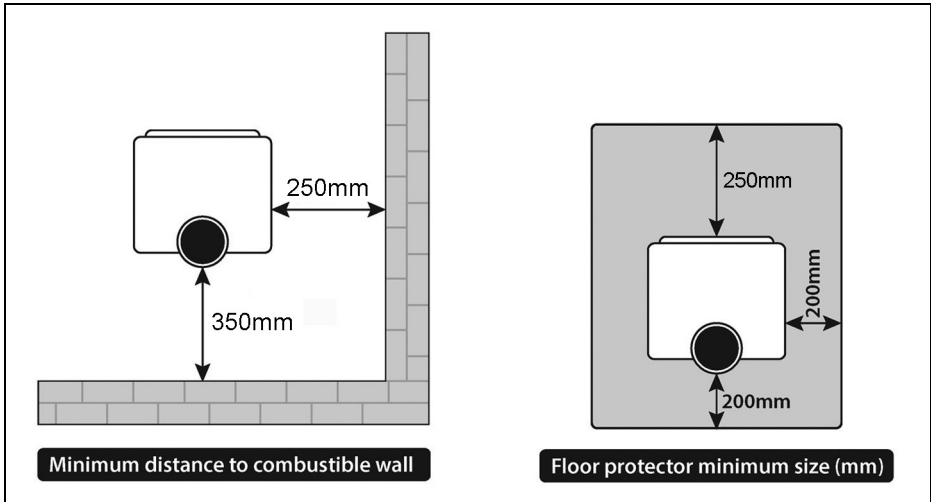

It is recommended that the stove be installed at least 700 mm from combustible materials which could be adversely affected by heat.

The stove can be recessed in a suitable sized fireplace but a permanent free air gap of at least 400mm must be left around the sides and top and at least 700mm at the back of the stove to obtain maximum heat output and for access to the rear of the stove.

MINIMUM DISTANCE TO COMBUSTIBLE MATERIALS

Note: combustible material refers to any material that will degrade when subjected to heat e.g. plaster.

Due to the heat of a hot stove, a suitable fire guard should always be used to provide additional protection. Never allow young children to be left unsupervised in a room containing a hot stove.

Note; If in doubt, refer to the Building Regulations 2000 Approved Document "J".

CHIMNEY CONSTRUCTION

The stove is supplied with both a top and rear flue pipe connector. It should never be connected to a shared chimney/flue system.

Flue pipes with a smaller cross-sectional area than that of the stove outlet should never be used and must not project into the chimney connector, such as to cause a restriction to the gas flow.

Sizes of flues in chimneys are stipulated in Table 2 of the Building Regulations 2000 Approved Document "J" as follows:

1. Stoves under 20kW rated output which burn smokeless or low volatile fuel require a minimum flue size of 125mm diameter (or rectangular flues having the same cross-sectional area and a minimum dimension not less than 100mm for straight flues or 125mm for flues with bends or offsets.
2. Stoves of up to 30kW rated output burning any fuel require 150mm diameter (or rectangular flues having the same cross-sectional area and a minimum dimension not less than 125mm.

Liners should be installed in accordance with their manufacturers instructions. Appropriate components should be selected to form the flue without cutting and to keep joints to a minimum. Bends and offsets should be formed only with the matching factory-made components. Liners need to be placed with the sockets or rebate ends uppermost to contain moisture and other condensates in the flue. Joints should be sealed with fire cement, refractory mortar or installed in accordance with their manufacturers instructions. Ensure the joints are completely sealed as air leakage will lead to poor performance. Avoid having more than two bends in the flue system. Any offset between bends should be minimised and the flue should be equipped with suitable access doors for inspection & cleaning. For further detail refer to Building Regulations document "J".

Special methods are required when passing through a wall or ceiling. Please refer to your local building regulations and/or fire department. Refer to Building Regulations Document "J".



CAUTION: THIS STOVE MUST NOT BE INSTALLED INTO A CHIMNEY THAT SERVES ANY OTHER HEATING APPLIANCE. THERE MUST NOT BE AN EXTRACTOR FAN FITTED IN THE SAME ROOM AS THE STOVE, AS THIS CAN CAUSE THE STOVE TO EMIT FUMES INTO THE ROOM

FLUE HEIGHT

The chimney height and the position of the chimney should conform to the Building Regulations document "J". Flues should be high enough to clear the products of combustion. The height necessary for this will depend on the type of the stove, the height of the building, the type of flue and the number of bends in it, and an assessment of local wind patterns. However, a minimum flue height of 4.5m could be satisfactory if the guidance in paragraphs 2.10 to 2.12 of the Approved Document "J" is adopted.

FIG 4

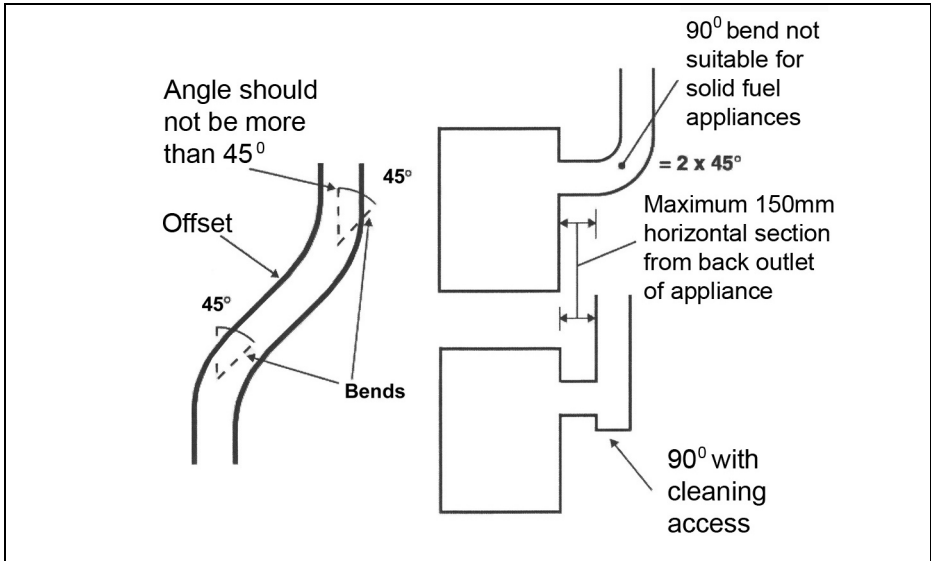

External flue pipes should be “twin wall”. These retain the heat, enabling it to rise and disperse from the chimney.

As an alternative approach, the calculation procedure within BS EN 13384-1 (2005) can be used as the basis for deciding whether a chimney design will provide sufficient draught. If in doubt, consult the Building Regulations.

The outlet from a flue should be above the roof of the building in a position where the products of combustion can discharge freely and will not present a fire hazard, whatever the wind conditions.

BENDS IN FLUES

Openings for inspection & cleaning should be formed using purpose factory-made components compatible with the flue system, having an access cover that has the same level of gas-tightness as the flue system and an equal level of thermal insulation.

Offsets in flues are only acceptable if the following rules are respected:

- The chimney system shall have no more than 4 bends in total; - 2 bends in the chimney and 2 bends in the flue pipe connection.
- The offset shall provide a change of direction no more than 45 degrees from the vertical.
- Maximum length of horizontal flue must not exceed 150mm (6”).
- The run of the chimney between bends shall not exceed 20% of the total chimney length.

FLUE PIPE COMPONENTS REQUIRED

FIG 5

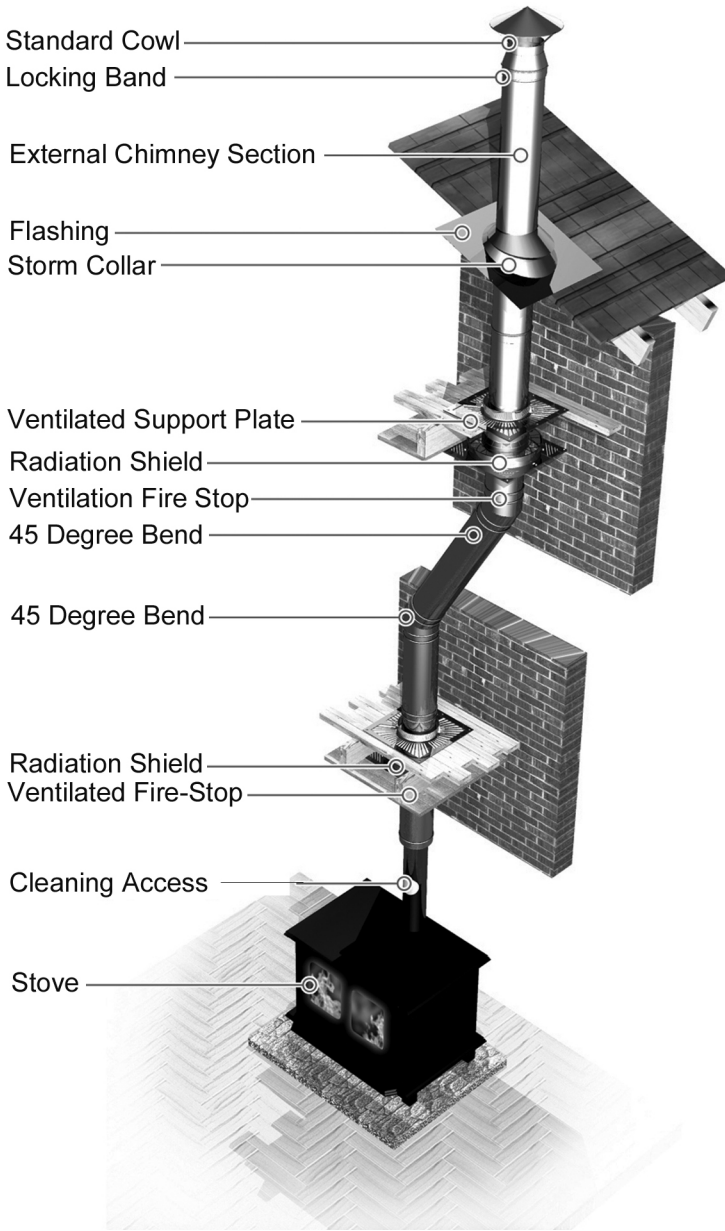

A wide selection of flue pipes, connectors and other components as shown above is available from your CLARKE stockist. See pages 25/26.

INSPECTION & CLEANING

Check that the chimney is in good condition, dry and free from cracks and obstructions. The diameter of the chimney should not be less than 150mm and not more than 230mm. If any of these requirements are not met, the chimney should be lined by a suitable method.

The chimney must be swept before connection to the stove. Where the chimney is believed to have previously served an open fire installation, it is possible that the higher flue gas temperature from the stove may loosen deposits that were previously firmly adhered, with the consequent risk of flue blockage. It is therefore recommended that the chimney be swept a second time within a month of regular use after installation.

Assuming that when the stove is first installed, the chimney is clean, and sound, then the chimney flue should be inspected part way through the burning season to establish the regularity of sweeping required. If you have any doubts about the suitability of your chimney, consult your local dealer/stockist.

If there is no existing chimney, then a prefabricated block chimney in accordance with Building Regulations Approved Document J, or a twin-walled insulated stainless steel flue to B.S.4543 can be used. These chimneys must be fitted in accordance with the manufacturer's instructions and Building Regulations.

FLUE DRAUGHT

A flue draught of approx 12 Pa is required for satisfactory stove performance. The flue draught should be checked under fire at high output. If it exceeds the recommended maximum, a draught stabiliser must be fitted so that the rate of burning can be controlled to prevent over-firing. If the reading is less than the recommended minimum, then the performance of the stove will be compromised.

AIR FOR COMBUSTION

Any room or space containing a stove should have a permanent air vent opening of at least the sizes shown in the table below. For stoves designed to burn a range of different solid fuels, the air supply should be designed to accommodate burning the fuel that produces the highest heating output.

There must always be a permanent means of providing air for combustion into the room in which the fire is installed. A permanent vent with a total free area of at least 550mm² for every kW rated above 5kW should be connected directly to the outside air or an adjacent room which itself has a permanent vent of the same size direct to the outside air.

The fitting of an extractor fan to either of these rooms is not permitted.

Stove Air Supplies	
Stove with flue draught stabiliser	<p>Permanently open vents as below:</p> <p>If design air permeability $>5.0\text{m}^3/(\text{h}\cdot\text{m}^2)$ then $300\text{mm}^2/\text{kW}$ for first 5kW of appliance rated output $850\text{mm}^2/\text{kW}$ for balance of appliance rated output</p> <p>If design air permeability $<5.0\text{m}^3/(\text{h}\cdot\text{m}^2)$ then $850\text{mm}^2/\text{kW}$ for balance of appliance rated output</p>
Stove with no flue draught stabiliser	<p>Permanently open vents as below:</p> <p>If design air permeability $>5.0\text{m}^3/(\text{h}\cdot\text{m}^2)$ then $550\text{mm}^2/\text{kW}$ of appliance rated output above 5kW</p> <p>If design air permeability $<5.0\text{m}^3/(\text{h}\cdot\text{m}^2)$ then $550\text{mm}^2/\text{kW}$ for balance of appliance rated output</p>

CONNECTION TO THE CHIMNEY

This MUST be carried out by an accredited/competent person and/or approved by your local Building Control Officer before using the stove.

Any existing flue must be in good condition with suitable access for collection and removal of debris. Details of suitable linings for use with solid fuel are given in the Official HETAS guide that can be viewed on their website at www.hetas.co.uk

It is also important that suitable flue pipe complying with Building Regulations is used to connect the stove to the chimney flue and that suitable access is provided into the flue for regular inspection and sweeping of the flueways.

Chimneys should be as straight as possible. Horizontal runs should be avoided and the horizontal section should never exceed 150mm (6 inches) in length.

Flue connections must be well sealed.

With a vertical rear flue the chimney may be swept through the stove. If it is not possible to pass the sweeps brush through the stove, a soot door will be necessary. This may be either in the actual brickwork of the chimney or fitted in the register plate. Suitable positions of soot doors are shown in Figures 6-7.

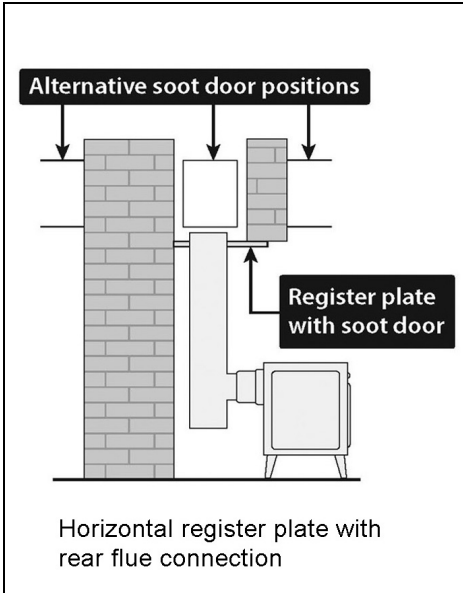
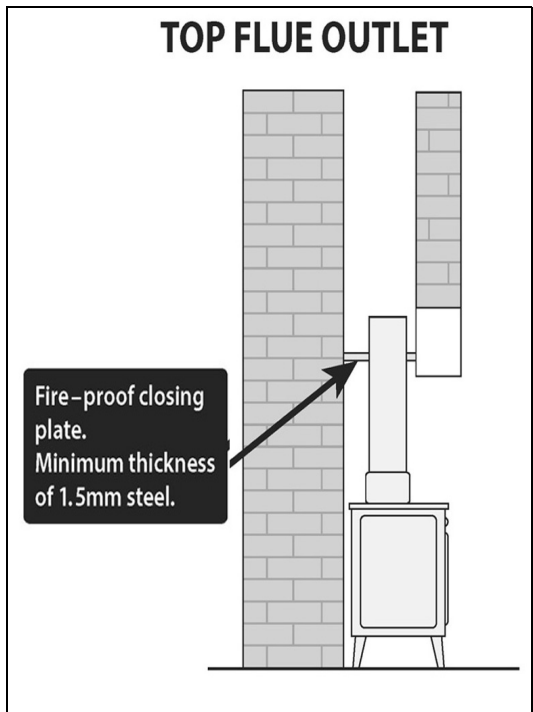

FIG 6

A non-combustible register plate minimum 1.5 mm thick should be fitted to all installations between the flue and the building structure. It's suitability and fit should be checked by a qualified stove installation engineer against the current Building Regulations App "J".

FIG 7



CLEANING THE FLUE

Access for cleaning the flue should be incorporated in the system other than through the appliance (e.g. a soot door or access through a register plate). Purpose-made soot doors and inspection lengths are available from the CLARKE range.

Ensure that the whole length of the flue can be reached from the soot door.

FUME EMISSIONS

To avoid chimney problems, your fire should not be burnt slowly for longer than 12 hours without a period of fast burning.

Properly installed and operated, this stove will not emit fumes although occasional fumes from de-ashing and refuelling may occur. Persistent fume emission must not be tolerated and if fume emission persists, the following immediate action should be taken:-

1. Open doors and windows to ventilate room.
2. Let the fire out or eject and safely dispose of fuel from the stove.
3. Check for flue chimney blockage and clean if required.
4. DO NOT attempt to re-light the fire until the cause has been identified and corrected.

If necessary, seek professional advice.

IMPORTANT: NEVER fit an extractor fan in the same room as this stove.

CARBON MONOXIDE ALARMS

Due consideration should be given to the dangers of carbon monoxide poisoning following incomplete combustion of solid fuels in an enclosed space. Carbon monoxide detectors to BS EN 50291 are available for use in domestic premises and details are available in the official HETAS guide that can be viewed on their website at www.hetas.co.uk.

Where a new or replacement fixed solid fuel appliance is installed in a dwelling, a carbon monoxide alarm should be provided in the room where the appliance is located.

Carbon monoxide alarms should comply with BS EN 50291 and be powered by a battery, designed to operate for the working life of the alarm. The alarm should incorporate a warning device to alert users when the working life of the alarm is due to pass. Mains-powered BS EN 50291 Type A carbon monoxide alarms with fixed wiring (not plug-in types) may be used as alternative applications, provided they are fitted with a sensor failure warning device.

The carbon monoxide alarm should be located in the same room as the stove:

- on the ceiling at least 300mm from any wall or, if located on a wall, as high up as possible (above any doors and windows) but not within 150mm of the ceiling and;
- between 1m and 3m horizontally from the stove.

NOTE: Further guidance on the installation of carbon monoxide alarms is available in BS EN 50292 and from manufacturers instructions. Provision of an alarm should not be regarded as a substitute for correct installation and regular servicing.

USING YOUR STOVE

STOVE CONTROLS



WARNING: THE TEMPERATURE REACHED BY THESE ITEMS DURING OPERATION MAY CAUSE AN INJURY TO AN END-USER. AS THESE ARE INTENDED TO BE ADJUSTED DURING OPERATION, IT IS RECOMMENDED THAT A PROTECTIVE MITT IS WORN WHEN HANDING THESE PARTS.

The amount of heat emitted by the stove is regulated using the air control.

Opening the air control vent A by moving the control lever can be used to revitalise the fire effectively, producing significantly more vigorous combustion and keeping the inside of the door glass clear of smoky deposits.



Control knob B is used to operate the secondary air wash control. By adjusting the degree to which the air-wash vent is opened, good control of the combustion rate can be achieved. This should be fully opened while combustion is being established.

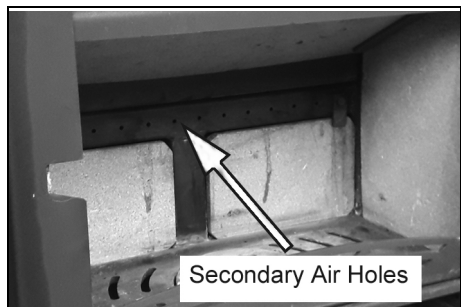

SUITABLE FUELS

This stove can be used in smoke controlled zones to burn wood/logs and all fuel should be dry and timber should be well seasoned so as to have a moisture content below 20%. The use of damp wood will result in more soot and tar deposits being left in the chimney, flue and stove, and will not release heat if thermal energy is being used to drive out moisture from the fuel.

The smoke control website includes details of fuels authorised for use in Smoke Control Areas but does not provide locations of Smoke Control Areas - the user should check with the Local Authority to determine if they are in a Smoke Control Area. The current address of the smoke control website is <https://www.gov.uk/smoke-control-area-rules>.

DO NOT use the stove to incinerate other materials including household waste. Avoid using 'green' unseasoned wood, treated wood such as telegraph poles, or plywood / chipboard containing glues and resins which pollute the environment and cause the fire to burn too quickly.

Such materials can produce excessive tar or creosote which can be damaging and in extreme cases cause a fire inside the chimney.

The dryness of wood can be assessed by looking at the end of the log. Radial cracks, deep enough to be considered as splits should be present in dry, seasoned logs.

The maximum length of fuel suitable for this stove is approx 28cm so as to lay flat over the embers and logs of greater than 10 cm diameter should be split.

Confirm with your fuel provider as to which type will suit best. Larger fuels will allow a greater draught in the firebox which will speed up combustion.

For further information on type and availability of fuel, the Solid Fuel Association (<http://www.solidfuel.co.uk>) serves as an advice centre to domestic consumers including all aspects of fuel types.

INITIAL SEASONING



CAUTION: THIS STOVE MUST BE SEASONED BEFORE USE. FAILURE TO CARRY OUT THIS IMPORTANT PROCEDURE WILL RESULT IN PERMANENT DAMAGE TO THE STOVE AND WILL VOID YOUR WARRANTY.

Following installation and before regular use, the stove must be seasoned to prevent cracking of the metal casting. This procedure should also be followed if the stove has not been used for prolonged periods (during the summer months for example) and is carried out as follows:

1. Light a small fire in the middle of the stove, well away from the sides.
2. Allow the stove to warm up slowly and evenly with the air controls almost closed, avoiding intense flames.
3. Keep the fire burning for three hours or so, gradually increasing the size of the fire using larger logs which will burn naturally but slowly, keeping the stove on a low setting.
4. After a couple of days burning at this level, increase the brightness & intensity of the fire gradually over the next 10 days.

Full strength fires should not be used until completion of approx 20 days of mild use. Only from this time will the stove have been properly seasoned.

It should be remembered that this procedure should be carried out at the beginning of each season of use in order to remove the moisture retained by the metal during the period of non-use.

When used for the first time the fireplace may smell a little, due to gas being given off. The gas is not toxic but the room should be thoroughly ventilated. Let the fire burn with a high draught until no smells can be detected.

Burning the stove at a very high temperature the first few times may damage the paint. Burn fires at a moderate level the first few days. DO NOT place anything on the stove top during the curing process as this may result in damage to your paint finish.

Take care not to open the stove door too vigorously in case of causing smoke spillage. If smoke spillage occurs after the fire door has been opened this could be due to poor chimney draft. SEE TROUBLESHOOTING ON P27.

STARTING THE FIRE

1. Open the air control.
2. Lay firelighters or rolled up newspapers on the grate with a reasonable quantity of dry kindling wood. Place 2 or 3 small logs on top.
3. Light the newspaper or firelighters using a long taper and close the door.
4. When the fire is burning strongly add further logs up to 10cm diameter.
5. When the stove is really hot, close the air control as required. Ensure there are lasting flames until the wood becomes charcoal.

REFUELLING

1. ALWAYS open the door slowly to avoid a sudden rush of intake air and smoke escaping into the room and add fuel.
2. Open the air controls and leave open for a few minutes to allow the gasses in the wood to burn before closing the air controls.
 - The rate of refuelling and heat available are dependant upon individual requirements based upon the user's experience. When re-loading, it is normally necessary to burn the stove fast initially, to drive off any gasses and moisture, before closing the air vents to control the burn rate.
 - Ensure the door is kept closed to contain fumes except when lighting up, re-fuelling or removing ash.
 - It is not recommended to leave the stove alight at night or to continue using the stove in mild weather which gives poor combustion leading to a greater buildup of soot.

- If overnight burning is required, it can best be achieved by first driving off any gasses or moisture as usual, following a full charge of fuel and then closing the air vents fully. Experience will indicate the optimum setting. However, by reducing the burn rate to such a level that the fire is still burning the following day, the burning process creates heavy, tarry chemicals which will become deposited on the inside of the flue or chimney. This is an inefficient process which greatly increases the risk of a chimney fire and makes it necessary to sweep the chimney more often.

ASH REMOVAL

Keep the stove free from a heavy buildup of ash. The frequency of this is dependant upon the type and quality of fuel being used. Ash should be removed before it builds up to the underside of the grate, at which point, the grate would be burning hot on both sides, shortening its life expectancy.

When disposing of ashes, ensure they have cooled and always place in a metal container. Be sure to remove the ash when the fire is at its lowest point, such as first thing in the morning.

The CLARKE ASHVAC1200 Vacuum Cleaner is ideal for collecting hot ash and debris from stoves.

MAINTENANCE

CLEANING

The inside of the stove may require regular cleaning, especially during periods of peak use, the frequency of this being indicated by experience. It is advisable to wear a dust mask, protective gloves and safety glasses when cleaning.

Use a stiff brush and industrial type vacuum cleaner to dislodge and remove as much material as possible, starting at the top of the stove and working down to the bottom. Particular attention should be given to the air inlet controls which can become obstructed. An ASHVAC1200 Vacuum Cleaner is ideal for this process.

GENERAL MAINTENANCE

Take this opportunity to check for any damaged parts inside the stove. In the event of damage or broken components, replacements can be obtained from Clarke Parts & Service. On no account should unauthorised spare parts be used.

The stove and flueway should be inspected and maintained when in a cold condition. NO unauthorised modification of this product should be carried out. This stove requires regular maintenance by a competent engineer.

STOVE BODY

The stove is finished with a heat-resistant paint which can be cleaned with a soft brush. Wait until the stove has cooled down before doing this. This finish can be renovated with stove paint, although the paint may not be an exact match and it may be necessary to repaint the complete stove.

If the stove is purely ornamental, painting will provide a durable, attractive finish. If the stove is used for heating, a high temperature heat resistant paint (available from your CLARKE dealer) must be used, in either aerosol or brush applied form. Should rust become apparent, clean thoroughly with a wire brush and apply a suitable anti-rust treatment.

During prolonged periods out of use, the air inlet should be left open and the door left slightly ajar in order to circulate fresh air and discourage condensation from forming which could encourage corrosion.

FIRE ROPE

Check the rope around the door and glass. If rope is in poor condition, replace with rope approved for this purpose.

Inspect the fireproof door seal where fitted, to ensure there is an effective seal around the door and re-fix it if loose using stove rope adhesive. If in poor condition it should be replaced.

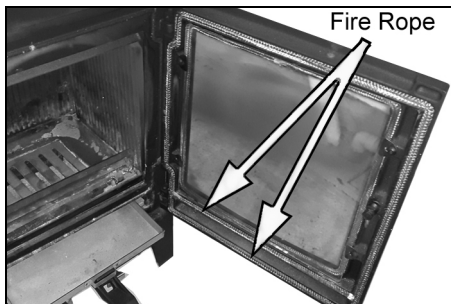

GLASS PANELS

Clean any glass panel when cool, avoiding abrasive substances which could scratch the glass and make subsequent cleaning more difficult. Wet logs against a heated glass, a badly aimed poker or heavy slamming of the door could crack the glass panel. The glass will not fracture with heat. Never replace any broken glass with glass NOT approved for use with stoves.

The window glass should remain clean during normal use but it can become blackened if the stove is being operated with either damp fuels or at a slow burn rate. The blackening may be dispersed by burning briefly at a much higher temperature or it may be cleaned off using specialist glass cleaner.

In the event of the glass being broken, it can be removed by unscrewing the retaining tabs, taking care not to damage the fireproof rope seal. The replacement glass should be carefully placed against the seal and the retaining tabs re-tensioned. Take care to tension these evenly or there is a risk of breaking the new glass pane.



CHIMNEYS AND FLUE-WAYS

It is important that the chimney, flue-ways and any connecting flue pipe are swept regularly. This means at least once a year for smokeless fuels and at least twice a year for wood and other fuels.

Only wire-centred sweep's brushes fitted with a guide wheel should be used. If it is not possible to sweep all parts of the chimney through the stove, ensure there is adequate access to cleaning doors.

If the stove is fitted in place of an open fire, then the chimney should be swept one month after installation to clear any soot falls which may have occurred, due to the difference in combustion performance between the stove and the open fire.

The flue and chimney should be inspected for a build-up of deposits especially following prolonged periods without use. The entire chimney/flue should be swept frequently from top to bottom by a registered chimney sweep to remove any build-up of soot etc, the frequency being dependant upon the usage and the fuels being burnt. If the chimney is swept after a few weeks of regular use, the condition found will give an indication of the frequency of sweeping required. On an annual basis, the chimney is best swept just before the main winter burning season.

HETAS recommends that chimney sweeping is best carried out by an approved chimney sweep who will normally be a member of the National Association of Chimney Sweeps or the Guild of Master Sweeps, details of which can be found on the HETAS website, www.hetas.co.uk.

ACCESSORIES

Refer to the CLARKE website www.clarkeinternational.com for a full range of Flue Pipes & Cows (both Vitreous Enamel or Stainless Steel) for use with this classic cast iron stove. See also the following accessories on page 26.

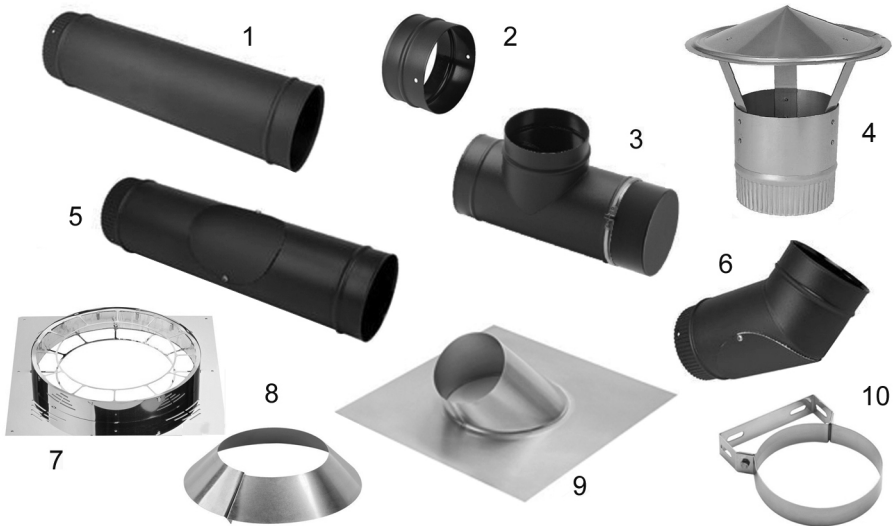

- | | | | |
|---|--------------------------|----|------------------------|
| 1 | Straight Flue pipe | 6 | 45 deg elbow with door |
| 2 | Flue connector | 7 | Ventilated fire stop |
| 3 | 90 deg Tee with soot box | 8 | Storm Collar |
| 4 | Twin wall standard cowl | 9 | Adjustable roof plate |
| 5 | Flue Pipe with door | 10 | Wall band |

Choose from the range of accessories suitable for use with this stove.

Part No 6910000: Fire Cement (1Kg tub)

Part No 6912215 & 6912220: Heat-powered Stove Fans CSF4 & 5

Part No 3402152: Logbuster H4 (230v)

Part No 3402048: Stand also available

See also Part No 3402032: Logbusters H5 and Part No 3402150: Logbuster V6

Part No 6910202: Glass Cleaner

Part No 6910204: Stove Cleaner Spray

Part No 6910206: Matt Black Stove Paint (500ml)

Part No: 1801617: Paper Briquette Maker

Part No: 6912112: Companion Set CS5

Part No: 6471130: 1200W Ash Vacuum Cleaner

An extensive range of flue components is also available from your CLARKE stockist.



ENVIRONMENTAL PROTECTION



Recycle unwanted materials instead of disposing of them as waste. All unwanted accessories and packaging should be sorted and taken to a recycling centre for disposal in a manner which is compatible with the environment.

TROUBLESHOOTING

PROBLEM	CAUSE	SOLUTION
Fire difficult to start.	Wood green, too damp or poor quality.	Use recommended fuel. See pages 19-20.
Fire goes out.	Logs are too large.	When lighting, use small, dry kindling. To maintain the fire use split logs.
	Air starvation	Open air control. See p19
	Insufficient draught.	Check that flue is not obstructed, sweep flue if necessary.
Fire burns too quickly.	Too much draught.	Ensure the air control is closed.
		Install a draught stabiliser. Consult your dealer.
		DO NOT continuously burn small wood, sticks, carpentry offcuts, plywood etc
Stove smokes when lighting up.	Flue duct is cold.	Burn paper and kindling wood to increase heat.
	Room is at negative air pressure to the outside.	In houses equipped with mechanical ventilation, open a window until the fire is well established.
Low heat output.	Incorrect fuels.	Use recommended fuels. See p19
Smokes while burning	Draught is insufficient	Consult a chimney specialist. Check that flue is not obstructed. Sweep if necessary.
	Downdraught present.	Install an anti-downdraught cowl. Consult your dealer.
	Room is at negative pressure to outside.	In houses equipped with mechanical ventilation, an outside air intake must be installed in the chimney.
Smoke spillage when opening door.	Chimney not tall enough to be clear of roof line.	Increase height of chimney.
	Poor sealing of flue-pipe joints.	Re-connect flue or replace jointing material
	Flue is partially blocked with soot.	Arrange to have chimney swept.
	House too tightly sealed.	Ensure a fresh air supply is reaching the stove.

COMPONENT PARTS

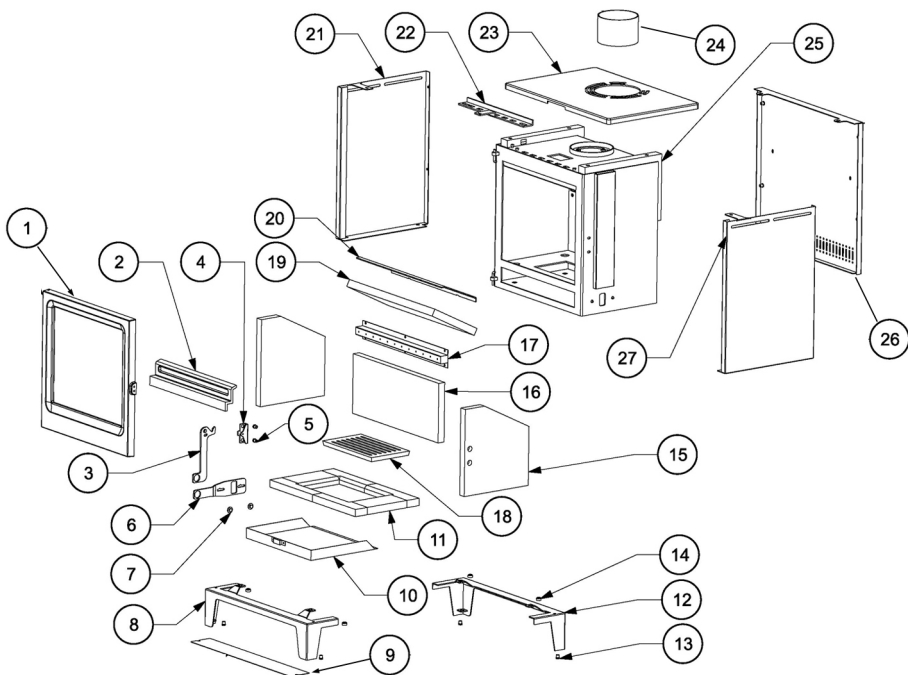

1	Stove Door
2	Log Retainer Bar
3	Door Handle
4	Door Handle Fixing
5	Screw
6	Primary Air Inlet Control
7	Screw
8	Pedestal Front Section
9	Spacer
10	Ash Pan
11	Grate Frame (Vermiculite)
12	Pedestal Rear Section
13	Adjusting Screw
14	Fixing Screw

15	Vermiculite Side Firebrick
16	Vermiculite Rear Firebrick
17	Rear Air Inlet
18	Grate
19	Lower Baffle Plate
20	Top Baffle Plate
21	Left Panel
22	Secondary Air Inlet
23	Top Panel
24	Flue Adaptor
25	Fire Box
26	Rear Panel
27	Right Panel

WE ALSO SUPPLY A GREAT SELECTION OF  PRODUCTS TO USE WITH YOUR STOVE AND TO HELP YOU PREPARE YOUR STOVE AND LOGS



Companion sets



Paper Briquette Maker



Stove Thermometer



Electric Chain Saw

LOG SAWS & SPLITTERS

COMPANION SETS



Black enamel & stainless steel flue pipes & cowls (B.S. approved)

ASHCANS

FLUES, PIPES AND COWLS



Log Saws



Fire Cement



Heat powered stove fans

Ash vacuum cleaner

Range of Logbusters



Stove paint & cleaners

PLEASE CONTACT YOUR LOCAL  STOCKIST FOR ANY OF THESE ITEMS

PARTS & SERVICE: 020 8988 7400

E-mail: Parts@clarkeinternational.com or Service@clarkeinternational.com

SALES: UK 01992 565333 or Export 00 44 (0)1992 565335

Clarke INTERNATIONAL Hemnall Street, Epping, Essex CM16 4LG
www.clarkeinternational.com